



# INSULATED SECTIONAL GARAGE DOORS



Great to come home to...



Made for remote control!



# HARMONY OF STYLE

and reliability of  
automation & design  
- distinctive features  
of Alutech Trend  
garage doors

Warm, reliable and safe doors ensure comfort and convenience every day. The wide choice of designs and colours for Trend garage doors will help to emphasize individual design of modern architecture in contemporary style or classic cottage. Trend garage doors can be installed in any garage. Trend garage doors are all made to measure so will suit any style or shape of opening.

# CONTENTS

Nine reasons in favour of ALUTECH Trend garage doors	4
Energy efficient garage doors	8
The Trend range of garage doors	10
Doors made from L-ribbed panels	14
Doors made from M-ribbed panels	18
Doors made from S-ribbed panels	22
Doors made from Georgian panels	26
Doors made from Microwave panels	30
Wicket door	34
Side door	38
Accessories	40
Reveal fit	41
Automation systems	42
Advantages summary	46
Technical information	48
About Alutech	52



Great to come home to...



# 9 REASONS in favour of Trend garage doors







## EFFICIENT THERMAL INSULATION



Trend garage doors are good at keeping heat in the premises, providing a comfortable temperature and saving on heating costs in the winter. The thermal transmittance coefficient for Trend garage doors is:

- Trend Series (panel 40 mm)—**1,35 W/(m<sup>2</sup>K)\***;

Thermal insulation **U = 1,35 W/(m<sup>2</sup>K)** is comparable with a brick wall of **55 cm** thickness. Trend garage doors are supplied all over Europe, including some of the coldest regions.



## MADE FOR REMOTE CONTROL AUTOMATION

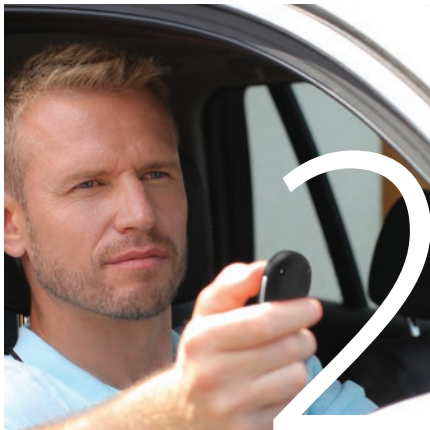

Paired with the beautifully designed Levigato openers or LiftMaster® openers with their myQ® smart phone control option, effortless operation of your garage door is assured.

Reliability is proven with millions of openers installed around the world and safety is inherent with all systems meeting current safety standards and CE marked.

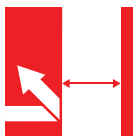

## DURABILITY, SECURITY AND RELIABLE PROTECTION



40mm thick sandwich panels, provide the foundation for durability, robust construction, and resistance to impact and wind loads.

Security is excellent with the door presenting a solid “wall”, held in place by multiple rollers and full length steel guide tracks.

Great to come home to...



LONG  
OPERATIONAL  
LIFE



Trend sandwich panels have a closed loop design where steel sheets are interfixed into a 'lock'. Such a design protects panels against delamination in the sun and in the case of sudden closing of doors or similar damage, prolonging the operation of the door.



RESISTANCE  
TO CORROSION



Corrosion resistance is robust and is provided by:

- thickness of zinc coating (**16 micron**);
- double layer paint-and-lacquer coating (**PUR-PA**) **35-40 micron** thick.

Warranties apply to doors that have received appropriate levels of care and maintenance as described in the warranty conditions (full details available at [www.garagedoorsystems.co.uk](http://www.garagedoorsystems.co.uk)) Particular emphasis on care is required in areas affected by airborne salts and pollutants.



RELIABLE  
SEALING



Trend garage door seals are manufactured from EDPM, a soft sealing rubber compound that substantially reduces heat loss.

Door brackets are designed to allow fine adjustment, between the door panel and garage structure, helping to eliminate gaps and any resulting heat loss.



SAFETY



Safety is always first on our list. All products' are independently tested and certified to comply with the highest safety requirements of the European Safety Norm EN 13241-1. We CE mark our doors.

Design of Trend garage doors provides protection against:

- Finger trapping
- Spring breakage device

Conformance to European standards EN 12604, EN 12453, EN 12424, EN 12425, EN 12426.



MAXIMUM SPRING  
ENDURANCE



Lifetime of springs on Trend garage doors is up to **25 000 open/close cycles** which corresponds to approximately **17 years** of operation with 4 open/close cycles per day.

Springs capable of **25 000 open/close cycles** are included as standard at no extra charge.



WIDE  
POSSIBILITIES  
with no extra charge



Trend garage doors are made to measure at no extra charge.

A wide choice of panels and colours are available to suit any style. Trend garage doors have 5 panel types and many different standard colours.

For the individual look, Trend garage doors are available with a bespoke painting service to any RAL colour\*\*

Great to come home to...

\*\* When providing a RAL reference for matching please note: A precise match cannot be expected. There will be a variation due to paint formulation and the surface to which the paint is applied resulting in a difference in shade, density or surface sheen.



# ENERGY EFFICIENT



Due to the greater panel thickness and special construction of Trend garage doors, excellent thermal insulation of premises is assured

**TREND GARAGE DOORS THERMAL TRANSMITTANCE IS  $1,35 \text{ W}/(\text{m}^2\text{K})^*$ , WHICH IS COMPARABLE WITH BRICK WALL 55 CM THICK**

\* For doors from Trend Series based on tests conducted by the ift. Rosenheim GmbH

# GARAGE DOORS

SANDWICH PANEL 40 mm —  
is one of the most robust in Europe

1 The 40mm polyurethane filled panels greatly influences the doors **thermal transmittance**. The greater the panel thickness, the lower the thermal transmittance.

2 Panels have polymeric **EPDM-seals** that ensure high mechanical endurance and flexibility at low temperatures. The seals prevent gaps between panels providing high thermal and sound insulation.

3 **Polymeric sealing** inserts are used to seal top and side of the opening, which provides additional protection against heat loss.

The flexible bottom seal helps reduce minor inconsistencies in the floor. To achieve an effective seal the door must close against a level surface – see page 51 for further information.

4 The space between steel sides is filled with **foamed polyurethane** which has high thermal insulating properties.



Great to come home to...





# DOORS FOR ANY CONDITIONS

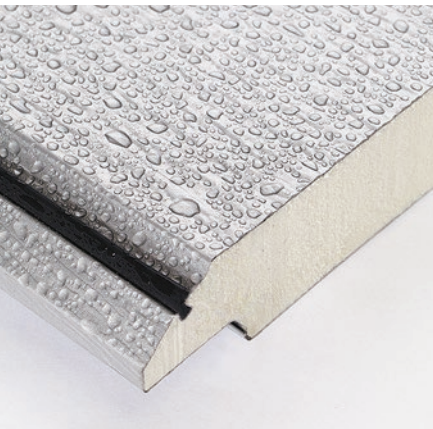





# Trend

Trend Series garage doors are economical and functional doors of 40 mm thickness with fittings made of galvanized steel, which are optimally suited for regions with temperate and cold climates. They comply with European standards; in addition all the safety systems are available at no additional charge. The standard door package includes a spring with a maximum lifetime when compared to competitors—of up to 25,000 open/close cycles. Trend Series garage doors are safe and practical doors at a reasonable price.

## Characteristics

- The thickness of a sandwich panel is 40 mm
- The thermal transmittance coefficient is **1,35 W/(m<sup>2</sup>K)\***
- Door brackets and intermediate hinges are made of galvanised steel
- Can be installed in an opening greater than the ordering size
- Curtain balancing with tension springs or torsion springs
- The maximum size of the garage doors is 6000×3250 mm

**Comparable to a brick wall of 55 cm thickness**



Made for  
remote  
control!

Great to come home to...

# Trend—AFFORDABLE, SAFE AND RELIABLE DOORS



WIDE  
OPPORTUNITIES  
OF INSTALLATION



Optional colour matched side and head/top profile means that our doors are able to be positioned slightly into the opening if desired.

These design elements are made of hot-galvanised steel, which is further coated with a protective lacquer coating (standard—white colour **RAL 9016**). At your request, door frames and the cover strip can be painted in the colour of the door leaf so that it will add to the doors harmonious appearance.



PROTECTION  
AGAINST  
CORROSION

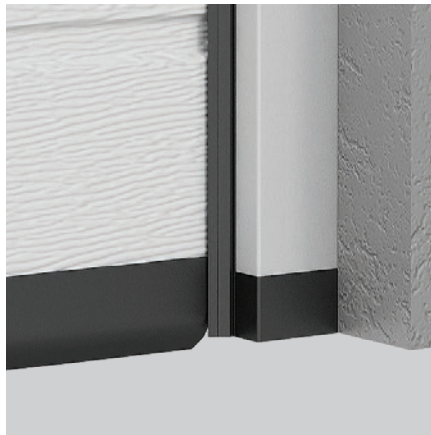

In heavy rainfall, water can collect at the bottom of the doors. **The polymeric base of the door frames** minimises the possibility of corrosion in high humidity environments, maintaining the attractive appearance of doors.



LONG-LASTING  
OPERATIONAL LIFE



The side spring mechanism, used for doors up to 4.5m wide, can be fully enclosed with optional spring covers for extra safety. This eliminates finger traps and enhances the doors appearance by covering the spring mechanism. The covers are shown in red with the side springs exposed for clarity.

In conjunction with regular servicing and maintenance, the lifetime of springs is up to **25 000 open/close** cycles. This corresponds to **17 years** of service with 4 times daily opening/closing during the period.

Advanced technology and years of experience in manufacturing has allowed us to create doors that have a number of advantages. Carefully thought-out design and high-quality components provide attractive design, reliable and safe operation of **Trend garage doors** for many years.



EFFECTIVE  
SAFETY

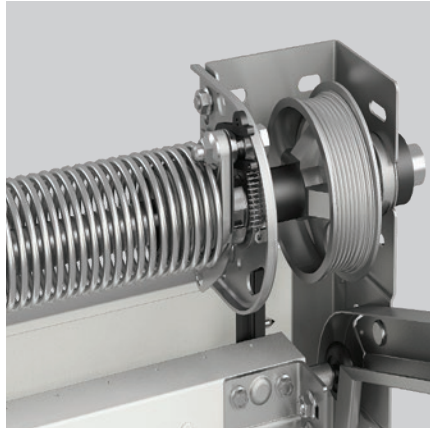

Torsion springs are equipped with **spring brakes** that stop the door leaf from falling in the case of spring breakage. This protection system is supplied at no extra cost and ensures safe operation.

Trend garage doors comply with European standard EN 13241-1, EN 12604, EN 12453, EN 12424, EN 12425, EN 12426.



PROTECTION  
AGAINST  
DRAUGHTS

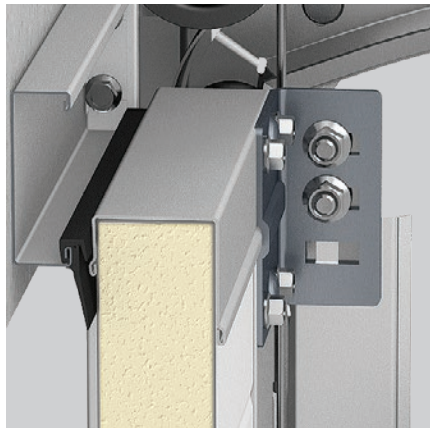

**Adjustable rolling brackets** allow the top panel to seal directly to the top profile. This greatly reduces draughts and heat loss.

This adjustment will be set to its optimum during installation. It is also possible to make fine adjustment over the years to ensure your Trend garage door will always be energy efficient.



SMOOTH  
MOVEMENT



Alutech is one of only a few manufacturers that include **ball race bearings within the rollers**. This allows for a much smoother operation, reducing the amount of noise of the door.

These bearings are of a closed type that are protected from dust and moisture, and do not require any lubrication.

Great to come home to...





HARMONIOUS GARAGE DOORS  
MADE FROM  
**L-RIBBED** PANELS





Made for  
remote  
control!

Great to come home to...





## SECTIONAL GARAGE DOORS FROM **L-RIBBED** PANELS

### **Trend**

Maximum door dimensions:  
**6000x3000 mm**



External surface of a panel **Woodgrain or Smooth**

3 Standard colours

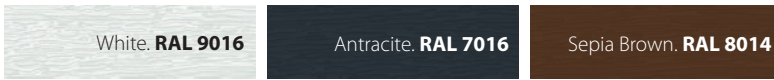

20 RAL colours



It is possible to finish doors in other **RAL colours\*\***

**L-RIBBED** PANEL

Wood finish colours

External surface of a panel **Smooth**

3 Wood Effect colours

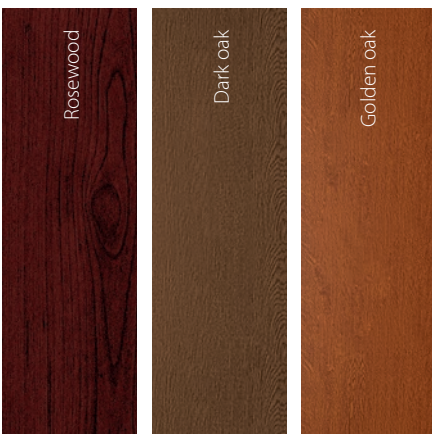

Woodgrain effect doors provide a realistic alternative to wood that will compliment your home. Its exclusive finish will look as good in the future as it will now.

Colours shown are for guide purposes only and are limited by the printing process. Always request to see a finish sample for confirmation of colour. RAL numbers are provided as the nearest approximation to the colour and will not match precisely.

Door leaf made from **L-ribbed** panels



Internal surface of a panel is **Textured**

Standard colour White-and -grey (close to **RAL 9002**)

It is possible to finish doors in other **RAL colours\*\***

Great to come home to...

\*\* When providing a RAL reference for matching please note: A precise match cannot be expected. There will be a variation due to paint formulation and the surface to which the paint is applied resulting in a difference in shade, density or surface sheen.



ELEGANT GARAGE DOORS  
MADE FROM  
**M-RIBBED** PANELS





Made for  
remote  
control!

Great to come home to...





Garage doors made from **M-ribbed panels** are distinguished with a modern and elegant design. They perfectly match with the architecture of most private cottages and houses.

# M RIBBED PANELS

## SECTIONAL GARAGE DOORS MADE FROM **M-RIBBED** PANELS

### **Trend**

Maximum door dimensions:  
**6000x3000mm**

External surface of a panel **Woodgrain or Smooth**

3 Standard colours

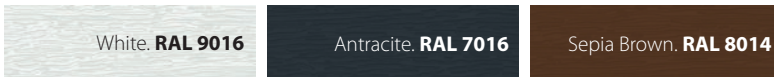

20 RAL colours



It is possible to finish doors in other **RAL colours\*\***

Door leaf made from **M-ribbed** panels



Internal surface of a panel is **Textured**

Standard colour  
White-and -grey (close to **RAL 9002**)

It is possible to finish doors in other **RAL colours\*\***

## M-RIBBED PANEL

# Wood finish colours

External surface of a panel  
**Smooth**

3 Wood Effect colours

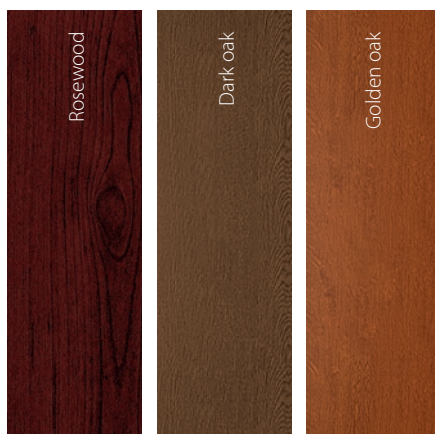

Woodgrain effect doors provide a realistic alternative to wood that will compliment your home. Its exclusive finish will look as good in the future as it will now.

Colours shown are for guide purposes only and are limited by the printing process. Always request to see a finish sample for confirmation of colour. RAL numbers are provided as the nearest approximation to the colour and will not match precisely.



Great to come home to...

\*\* When providing a RAL reference for matching please note: A precise match cannot be expected. There will be a variation due to paint formulation and the surface to which the paint is applied resulting in a difference in shade, density or surface sheen.





MODERN SECTIONAL DOORS  
MADE FROM  
S-RIBBED PANELS





Made for  
remote  
control!

Great to come home to...





A modern type of panel with horizontal ribs positioned at an even distance from each other. Due to symmetrical positioning of the horizontal ribs, junctions between panels are absolutely unnoticeable.

## SECTIONAL GARAGE DOORS MADE FROM **S-RIBBED** PANELS

**Trend** without wicket  
Maximum door dimensions:  
**6000x3000 mm**

**Trend** with wicket  
Maximum door dimensions:  
**6000x3000 mm**

External surface of a panel **Woodgrain or Smooth**

3 Standard colours

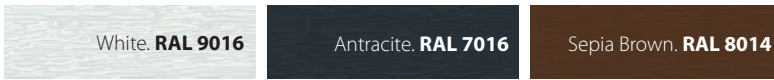

20 RAL colours



It is possible to finish doors in other **RAL colours\*\***

## S-RIBBED PANEL

# Wood finish colours

External surface of a panel  
**Smooth**

3 Wood Effect colours

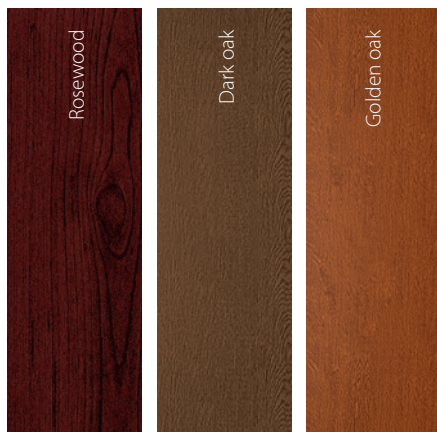

Woodgrain effect doors provide a realistic alternative to wood that will compliment your home. Its exclusive finish will look as good in the future as it will now.

Colours shown are for guide purposes only and are limited by the printing process. Always request to see a finish sample for confirmation of colour. RAL numbers are provided as the nearest approximation to the colour and will not match precisely.

Door leaf  
made from **S-ribbed** panels



Internal surface of a panel is  
**Textured**

Standard colour  
White-and -grey (close to **RAL 9002**)

It is possible to finish doors in other  
**RAL colours\*\***

Great to come home to...

\*\* When providing a RAL reference for matching please note: A precise match cannot be expected. There will be a variation due to paint formulation and the surface to which the paint is applied resulting in a difference in shade, density or surface sheen.





TRADITIONAL GARAGE DOORS  
MADE FROM  
**GEORGIAN PANELS**



Made for  
remote  
control!

Great to come home to...





**Georgian panels** are a classical variant for sectional garage doors. The Georgian features are positioned symmetrically creating a harmonious design of door leaf.

## SECTIONAL GARAGE DOORS MADE FROM **GEORGIAN PANELS**

### **Trend**

Maximum door dimensions:  
**5000x3150 mm**

External surface of a panel **Woodgrain**

2 Standard colours



20 RAL colours



It is possible to finish doors in other **RAL colours\*\***

Door leaf made from **Georgian panels**

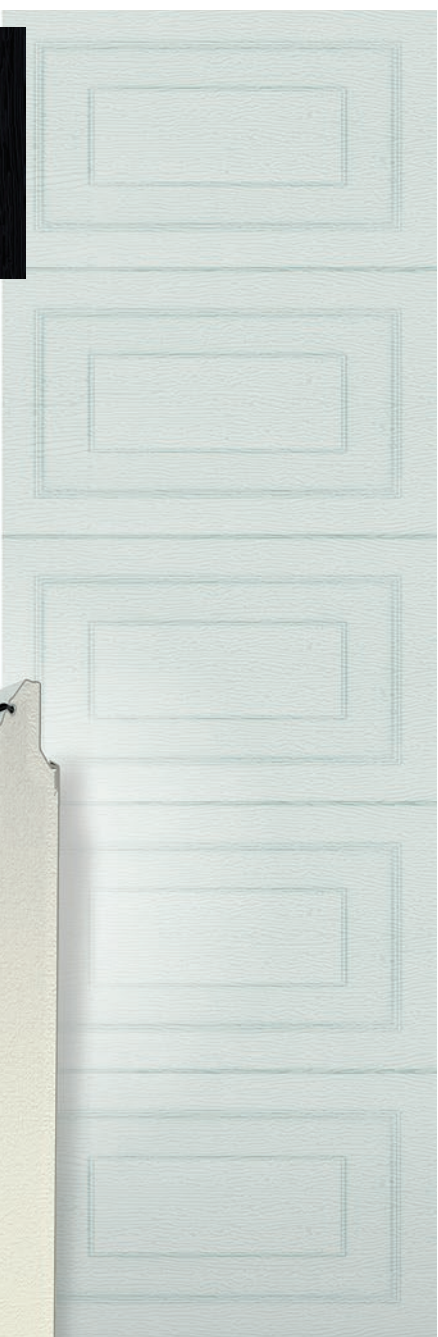

Panels  
of type **Georgian**

# Wood finish colours

External surface of a panel **Woodgrain**

2 Wood Effect colours



Internal surface of a panel is **Textured**

Standard colour  
White-and -grey (close to **RAL 9002**)

It is possible to finish doors in other **RAL colours\*\***

Colours shown are for guide purposes only and are limited by the printing process. Always request to see a finish sample for confirmation of colour. RAL numbers are provided as the nearest approximation to the colour and will not match precisely.

Great to come home to...

\*\* When providing a RAL reference for matching please note: A precise match cannot be expected. There will be a variation due to paint formulation and the surface to which the paint is applied resulting in a difference in shade, density or surface sheen.





PRACTICAL GARAGE DOORS  
MADE FROM  
**MICROWAVE** PANELS





Made for  
remote  
control!

Great to come home to...



# MICRO- WAVE PANEL

Elegant **microwaves** on the surface of the door leaf emphasise the modern architecture of new buildings. The 'microwave' pattern helps to hide minor damage to the paint-and-lacquer coating ensuring your doors remain attractive for a long time.

## SECTIONAL GARAGE DOORS MADE FROM **MICROWAVE** PANELS

**Trend** without wicket  
Maximum door dimensions:  
**6000x3000mm**

**Trend** with wicket  
Maximum door dimensions:  
**6000x3000mm**



External surface of a panel **Woodgrain**

3 Standard colours

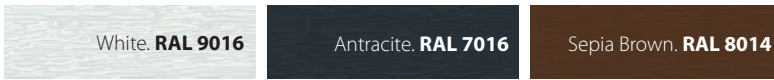

20 RAL colours



It is possible to finish doors in other **RAL colours\*\***



Texture **Woodgrain**

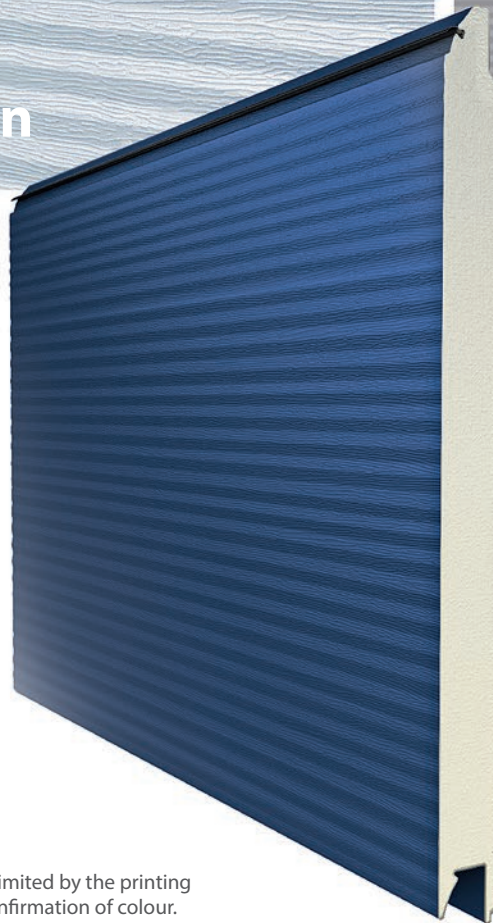

Door leaf type  
**microwave**



Internal surface of a panel  
**Woodgrain**

Standard colour White-and -grey  
(close to **RAL 9002**)

It is possible to finish doors in  
other **RAL colours\*\***

Colours shown are for guide purposes only and are limited by the printing process. Always request to see a finish sample for confirmation of colour. RAL numbers are provided as the nearest approximation to the colour and will not match precisely.

Great to come home to...

\*\* When providing a RAL reference for matching please note: A precise match cannot be expected. There will be a variation due to paint formulation and the surface to which the paint is applied resulting in a difference in shade, density or surface sheen.





WICKET DOOR —  
MAXIMUM  
OPPORTUNITIES



Great to come home to...



# WICKET DOOR



A **wicket door** is a practical and convenient solution. It allows entering the garage without opening the door itself.

## CONVENIENCE IN DETAIL

- Linear door closer
- Inbuilt sensor determines wicket position
- Available on doors up to 6000mm x 3000mm maximum  
3260mm x 2380mm minimum
- Rain visor
- Metal handles
- Special device eliminates sagging of wicket during use

Wicket doors are available built into garage doors series Trend with **microwave** panels and **S-ribbed** panels



### **STANDARD THRESHOLD, 145 mm**

For doors more than **4500x3000** mm  
Wicket with standard threshold has a reinforced construction.  
It is mounted into the doors with maximum dimensions.  
Maximum dimensions of doors with wicket are **6000x3000** mm

### **LOW THRESHOLD, 100 mm**

For doors less than **4500x3000** mm  
Wicket with low threshold conforms to requirements of fire safety.  
It can be mounted in areas of emergency exit location.



## **COLOURS FOR WICKET FRAMING**

Colour of wicket handle matches the colour of wicket framing



Brown  
(powder coating, colour close to **RAL 8019**)



Silver aluminium  
(anodized coating, colour **A00-D6**)



It is possible to paint the wicket profiles in other colours from the RAL range\*\*

Colours shown are for guide purposes only and are limited by the printing process. Always request to see a finish sample for confirmation of colour. RAL numbers are provided as the nearest approximation to the colour and will not match precisely.

Great to come home to...

\*\* When providing a RAL reference for matching please note: A precise match cannot be expected. There will be a variation due to paint formulation and the surface to which the paint is applied resulting in a difference in shade, density or surface sheen.



# SIDE DOOR WITH SECTIONAL DOORS

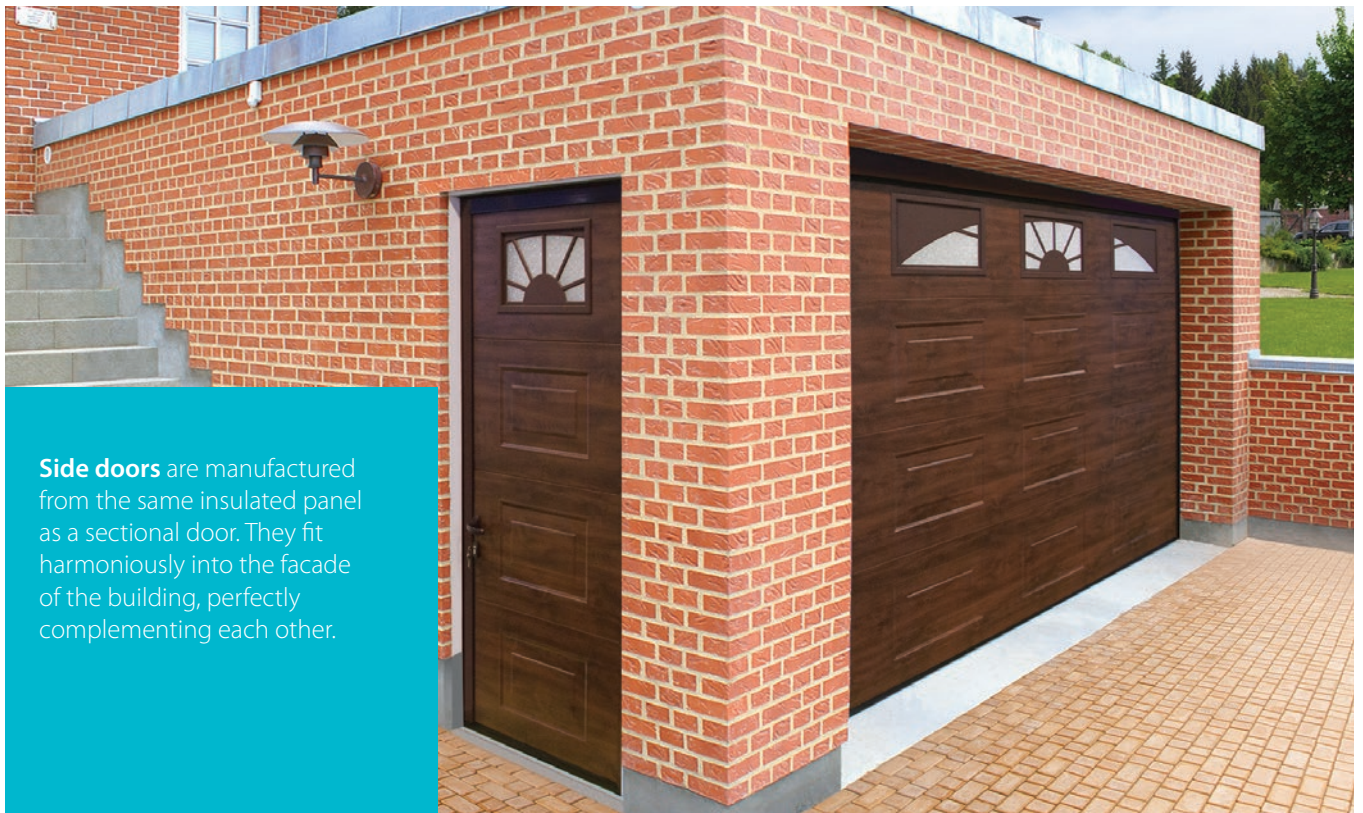

**Side doors** are manufactured from the same insulated panel as a sectional door. They fit harmoniously into the facade of the building, perfectly complementing each other.

The external frame of the side door is manufactured from extruded aluminium and can be finished in the same colour as the door leaf.

Side doors can be installed to open to left or right and open to the inside or outside of the garage.

Doors can be mounted as in between the brickwork opening or to the inside face to suit the customers specification

EPDM polyurethane sealing inserts are located along the door perimeter to ensure a reliable seal to the opening.

## VARIANTS OF DESIGN



Side door is installed with doors series **Trend**

It is possible to paint the side door profiles in other colours according to RAL catalogue\*\*

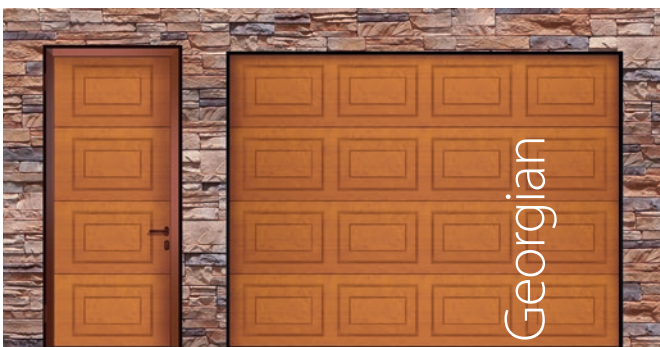
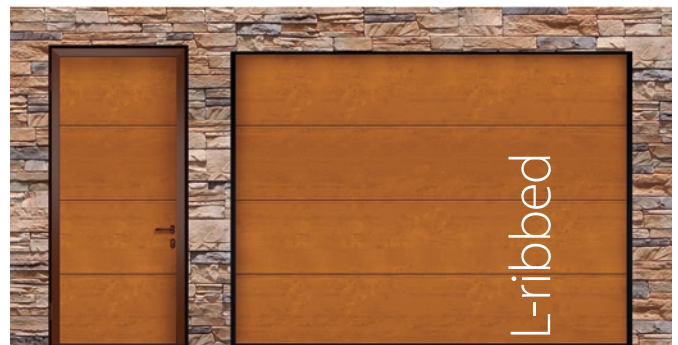
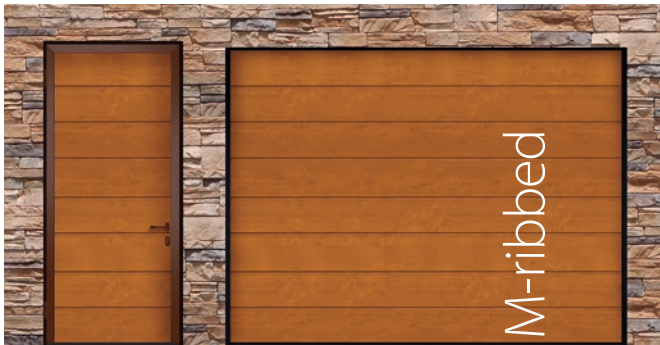

Rosewood is not available on Georgian design doors

Wood Effect colours are not available on Microwave design doors

# COLOURS

3 Standard colours

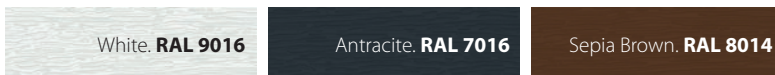

20 RAL colours



3 Wood Effect colours

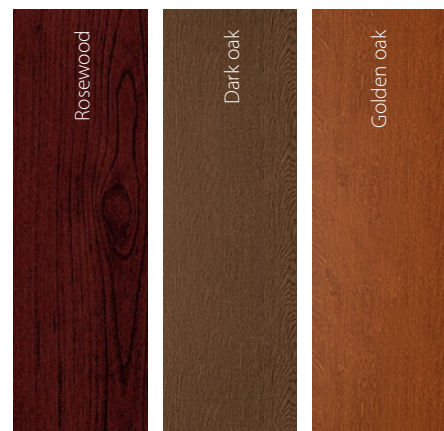

Colours shown are for guide purposes only and are limited by the printing process. Always request to see a finish sample for confirmation of colour. RAL numbers are provided as the nearest approximation to the colour and will not match precisely.

Great to come home to...

\*\* When providing a RAL reference for matching please note: A precise match cannot be expected. There will be a variation due to paint formulation and the surface to which the paint is applied resulting in a difference in shade, density or surface sheen.



# ACCESSORIES

for your comfort

## WINDOWS

Glazing for garage doors provides natural light and also contribute to the aesthetics of the door.

Windows are installed in **Trend** garage doors and can be colour matched to suit any panel design you choose:

- microwave
- S-ribbed panels
- M-ribbed panels
- L-ribbed panels
- Georgian panels

Frame and decorative inserts **Cross** and **Sunrise**—plastic

Colour of external frame and inserts—**white** or **brown**

If a coloured door is ordered the window surround and inserts are finished to the same colour as the door.



## EXTERNAL RELEASE FOR ELECTRIC DOORS

Where there is no other access into the garage, we offer an external manual release to allow the door to be opened in the event of a power failure.

## LOCK

For manually operated doors, you can choose a colour coordinated high security locking device. Key operated from the outside, your lock can be positioned in either the middle, left or right hand side of the door.



Classical rectangular window clear or stippled glass

Decorative glazing **Cross** clear or stippled glass

Decorative glazing **Sunrise** clear or stippled glass

Classical round window clear or stippled glass

Classical square window clear or stippled glass

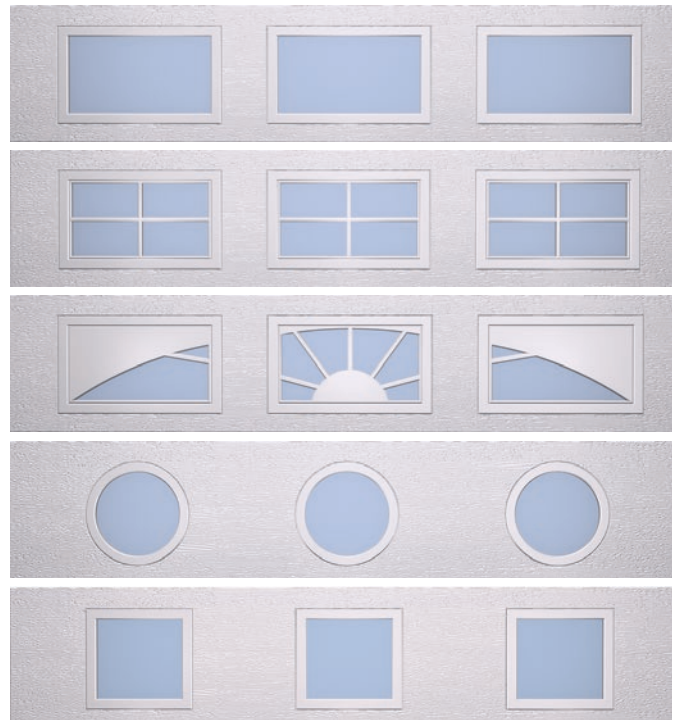

## STAINLESS STEEL WINDOWS

A choice of round or square windows with stainless steel frames is available for the contemporary design.

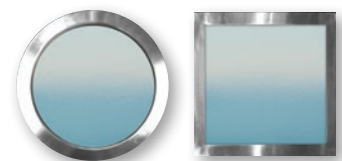

Clear glass only



# REVEAL FIT

## Unlimited options for mounting garage doors

### Set for reveal fit:

- set of side and top decorative covers
- set of brackets for fixing the track system to the wall

### Reveal fit is used for the following doors:

- **Trend** with tension springs
- **Trend** with torsion springs of low headroom type of mounting

Special option '**Reveal fit**' is offered for installation of sectional doors in non-standard openings of the 'tunnel' type, openings without top headroom or side room.

Reveal fit is often used when replacing old swing doors with sectional ones.

Reveal fit frame can be painted to match the colour of the door, alternatively it could be in a contrasting colour.

The reveal kit offers an alternative to installation on a wooden frame if there is insufficient side room to mount on the inside of the garage opening

Great to come home to...



# COMFORT



Additional accessories — for convenient control and safe operation of Trend garage doors.

Trend remote controlled automated garage doors are easily and effortlessly controlled from your car. This is especially convenient in bad weather, i.e. when it rains or snows. To open the door, you just need to press a remote control button.



# AND SAFE OPERATION

ALUTECH automation is the latest product in the company's range, the result of many years of experience, designed in a new conceptual style. Perfect harmony of tested reliability, functionality and understated elegance.



## LEVIGATO



- Motor with built-in control unit and radio receiver.
- Remote controls (2x).
- Belt drive rail.
- Installation kit.
- Installation and operation manual.

## 5 REASONS TO USE LEVIGATO AUTOMATION

- 1 HIGH FUNCTIONALITY**
  - High speed opening and closing of door – **up to 0,2 m/s** (for high speed drives).
  - **Built-in LED-lighting**, as well as an adjustable lighting duration delay.
  - Wide range of additional settings: adjustment of force, speed, acceleration and braking, auto-closing, wicket mode, etc.
- 2 RELIABLE SAFETY**
  - Compliance with European safety standards for automated doors.
- 3 RELIABILITY AND DURABILITY**
  - High endurance – no fewer than **30,000 cycles**, which is equivalent to **20 years** of daily operation.
  - Rigid and reliable rail with additional fixing points preventing from rail deflection when using high heavy doors.
- 4 SIMPLE COMMISSIONING**
  - Simple user-friendly set up interface: step-by-step setting using the list of the functions shown on the control unit.
  - Simple and fast setting of the final positions and recording of remote controls in one click (**express setup**).
- 5 UNIQUE DESIGN**
  - **The conceptual design** of ALUTECH automation was developed by experienced specialists from Pininfarina, a leading Italian agency specialising in the design of premium car bodies and home appliances.
  - **Built-in LED-lighting** for bright illumination of the garage.

Great to come home to...



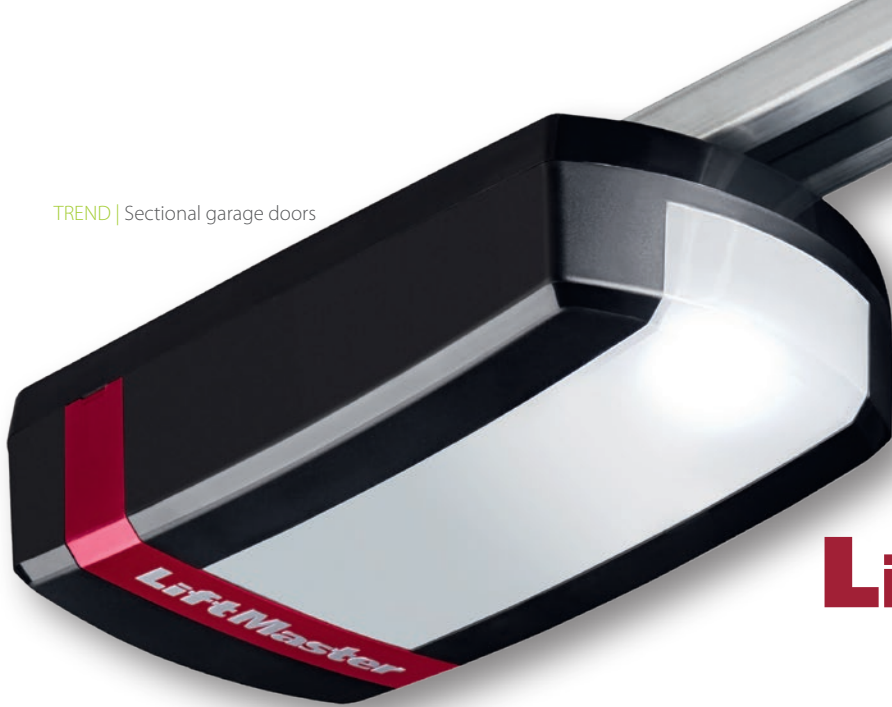

# EFFORTLESS

# LiftMaster®

**LM60 EVS**

**LM80 EVF**

**LM100 EVF**

- Motor with built-in control unit and radio receiver.
- Remote controls (2x).
- Wireless wall station
- Belt drive rail.
- Installation kit.
- Installation and operation manual.



Wireless Wall Control 128EV



LM80 EVF & LM100 EVF - Two 4-button mini transmitters



LM60 EVS - Two 2-button mini transmitters

The LiftMaster® range of three openers covers force ranges from 650N to 1000N to provide optimum power for all sizes of Trend garage doors.

## ACCESSORIES

### MYQ® KIT

Internet Gateway 828EV plus 770E Protector System™

Revolutionary new accessory with built-in myQ® technology that connects to the internet and allows monitoring and operating the garage door opener in or around your home or from anywhere in the world by using a smartphone or a computer. It utilises a two-way communication system. Easy and fast installation through in-home router. No annual activation fee.

### WIRELESS KEYPAD 747EV

Open or close your garage door without using a remote control or key. The LiftMaster Wireless Keyless Entry System can open the door using a private 4-digit code. Allows temporary access codes for visitors. Completely wireless, powered by one 9-volt battery (included). Weatherproof flip-up protective cover. Backlit keypad makes numbers easy to see, even in the dark.



# SMART CONTROL OPTION

LiftMaster® extends the capabilities of garage door automation technology into smart control by phone, tablet or PC

## THE WORLD'S NO.1

As a leading provider of convenience and security products for homes & businesses worldwide, LiftMaster's strong foundation emanates from the millions of products manufactured and sold since the early 1960s. Around the world, there are more LiftMaster openers installed than any other brand.



### MYQ® WORKS WITH NEST BY GOOGLE

LiftMaster's myQ® technology is the first garage door control system to be integrated with the Nest platform. The optional myQ® system allows you to set your Nest Learning Thermostat or Nest Cam using the myQ® app. You can also move seamlessly between apps allowing you to open or close your garage door from anywhere you can access the internet ...and watch it all happen if you set up a Nest Cam in your garage.



### PERMANENT LIGHTING

Long lasting LEDs (up to 50,000 hours of service), no warm up phase, so the light is bright immediately. Significantly lower CO<sub>2</sub> emissions and no heavy metal or mercury in the production process.



### WARRANTY

We have also increased the warranty period up to a maximum of 7 years (LM100EV) to demonstrate that LiftMaster provides premium quality products.



### SUSTAINABILITY

The low standby power consumption corresponds to savings of up to £230 over the life of the opener compared to the majority of garage door openers that are installed around the world.



### PULLING POWER!

The EVS range includes some of the most powerful openers on the market handling door weights up to a massive 130 Kg and 5.5m wide.



### SPEED

We have accelerated the speed of our operators to a maximum travel speed of 200 mm/sec for the LM80 and LM100 without having to pay a premium for this important distinguishing feature.



### EVOLUTION RADIO

Evolution garage door openers are equipped with the best radio performance ever with bi-directional radio – which means your garage door opener does not only receive signals, but also sends signals back.



### WHISPER QUIET

The quiet and smooth operation provided by the belt drive system is second to none – try it out!

Great to come home to...



# 1 THERMAL INSULATION

## SANDWICH PANEL

- External steel sheet
- Internal steel sheet
- Foamed polyurethane

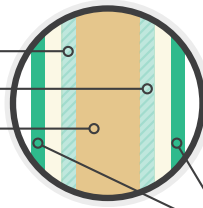

ALUTECH sandwich panels are 40mm thick.

## THERMAL INSULATION OF ALUTECH DOORS PANEL CORRESPONDS TO THE FOLLOWING MATERIALS

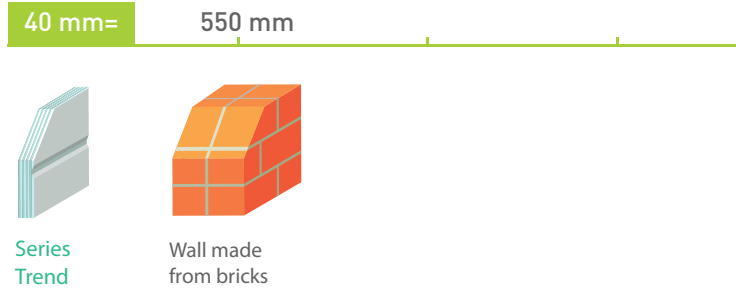

## THERMAL TRANSMITTANCE OF ALUTECH DOORS

**Trend Series**  $U = 1,35 \text{ W}/(\text{m}^2\text{K})$

based on tests conducted by the ift. Rosenheim GmbH

# 2 SOUND INSULATION

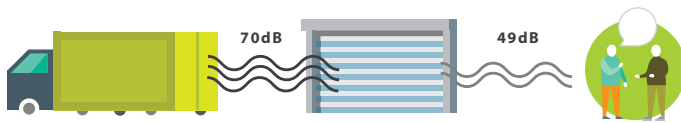

# 3 RELIABLE COATING

## RESISTANCE TO CORROSION

Zinc coating 16 microns thick and double layer polyurethane coating (25-35 microns) on the panel outer surface which is modified with polyamide particles (PUR-PA) which protects the sandwich panels from scratches and cuts caused by mechanical action and the effects of rain and coastal conditions.



# TREND SECTIONAL

7 MAIN AD



# 4 COMFORT

## DURABILITY

**25 000**

open/close cycles

## AUTOMATIC



Allows opening doors within **15 seconds**.



which is equal to

**17 YEARS**

of operation with 4 open/close cycles per day

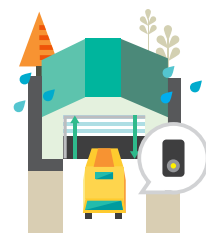

## IT IS KNOWN

The number of rainy days in Britain is 195.

# GARAGE DOORS

## VANTAGES



### 5 RESISTANCE TO WIND LOADS

Doors withstand wind speed up to 120 km/h.



### 6 EXCELLENT DESIGN

#### DIFFERENT PANEL PATTERNS

To suit all decorative styles.

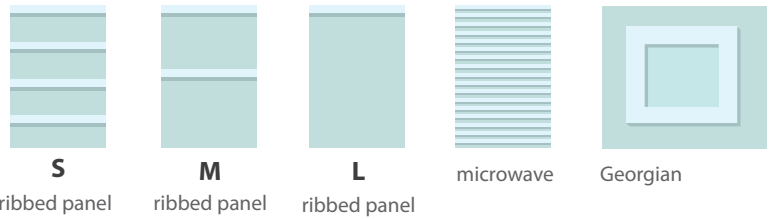

#### COLOUR RANGE

23 standard colours

Can be finished in all RAL colours (232 colours)



#### Wood finish colours



### 7 SAFETY

Correspond to European standards EN 12604 and EN 12453.

#### PROTECTION AGAINST DOOR LEAF FALLING

1 m<sup>2</sup> of door leaf weighs approximately 15 kg. Weight of medium size door of Classic Series (7 m<sup>2</sup>) — is more than 100 kg.

The door leaf is safely balanced with springs that do not move independently. A special device protects against spring break and the door leaf falling.



#### DOOR LEAF STOPS IF THERE IS AN OBSTACLE



#### PROTECTINO AGAINST FINGER TRAPPING



Sandwich panel design protects against finger trapping.

#### OPERATION



Allows operating doors without leaving the car.



Thus you will get wet 195 times less!

#### VERTICAL OPENING



Saving space in front of the garage.



Don't have to clear snow in front of the garage.



# TECHNICAL INFORMATION Side Extension Springs

## Side Extension Springs

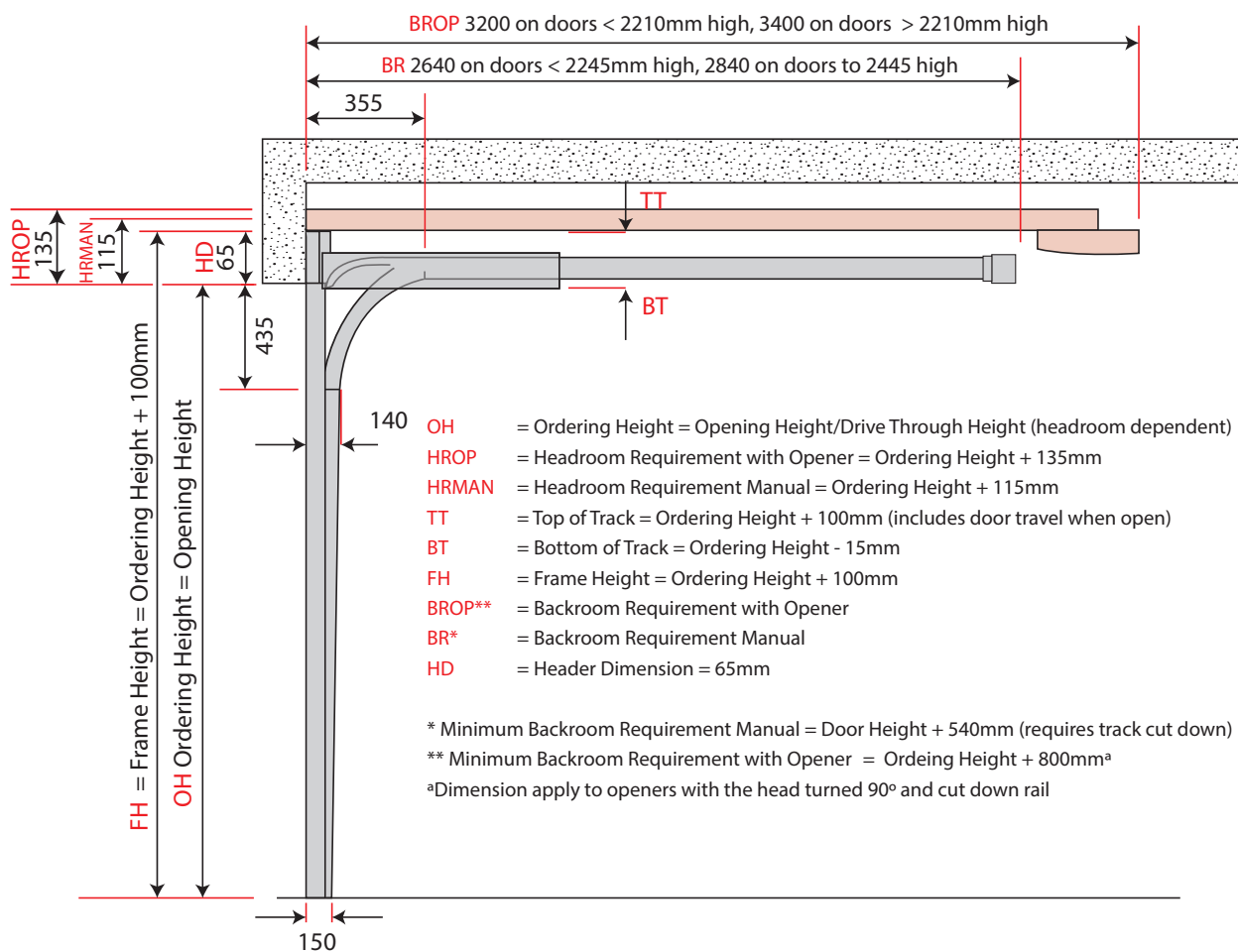

### Behind Reveal Fix

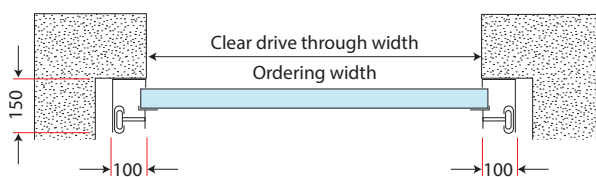

### Part Within Reveal Fix

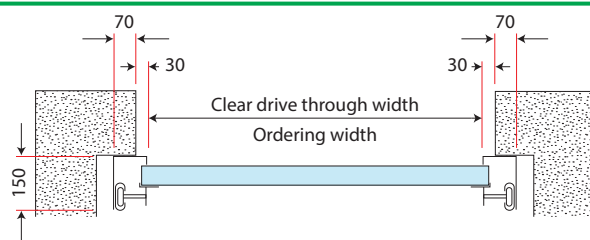

### Floor rebate

To help assist water draining away effectively from the door and prevent water ingress you must have a rebate (minimum

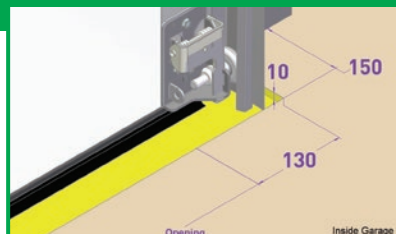

10mm) high behind the door threshold or where your door seal meets a level floor. If your floor is not rebated and not sloping away from the door you will be susceptible to water ingress as water will not be able to drain away effectively.

### Within Reveal Fix With Frame Covers

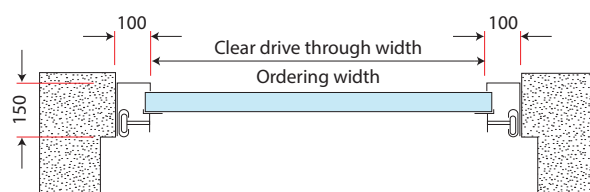

For "within the reveal fix" we recommend a minimum of 5mm fitting clearance each side, 10mm in total for brickwork coursing tolerance. For the door ordering size deduct 210mm from the narrowest point of the opening width. We also recommend an allowance of an additional 10mm clearance in height (subject to site conditions).

# TECHNICAL INFORMATION Rear Mount Torsion Springs

## Rear Mount Torsion Springs

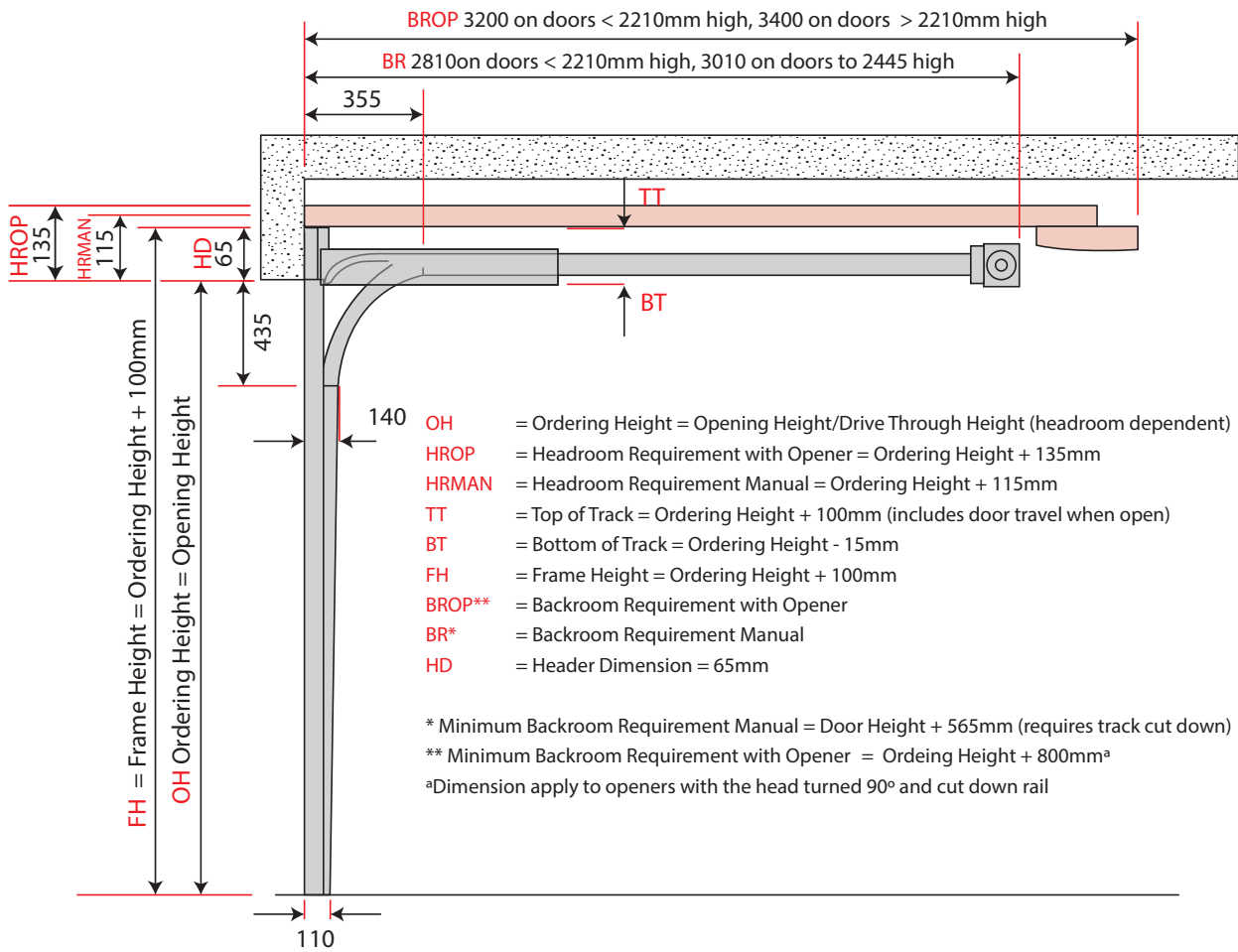

### Behind Reveal Fix

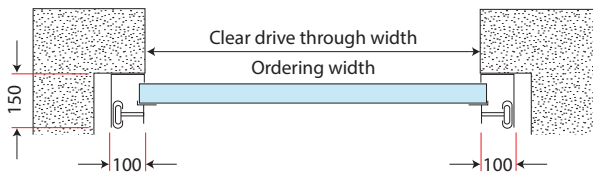

### Part Within Reveal Fix

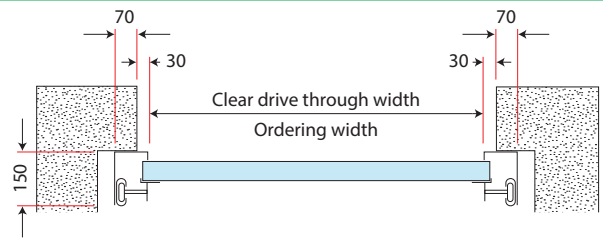

### Floor rebate

To help assist water draining away effectively from the door and prevent water ingress you must have a rebate (minimum

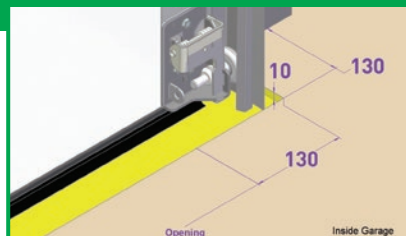

10mm) high behind the door threshold or where your door seal meets a level floor. If your floor is not rebated and not sloping away from the door you will be susceptible to water ingress as water will not be able to drain away effectively.

### Within Reveal Fix

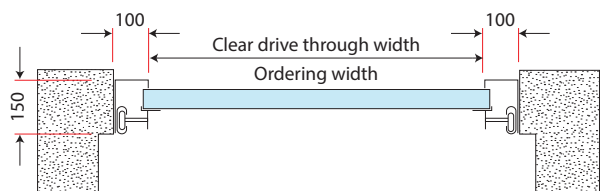

For "within the reveal fix" we recommend a minimum of 5mm fitting clearance each side, 10mm in total for brickwork coursing tolerance. For the door ordering size deduct 210mm from the narrowest point of the opening width. We also recommend an allowance of an additional 10mm clearance in height (subject to site conditions).

Great to come home to...



# TECHNICAL INFORMATION Front Mount Torsion Springs

## Front Mount Torsion Springs

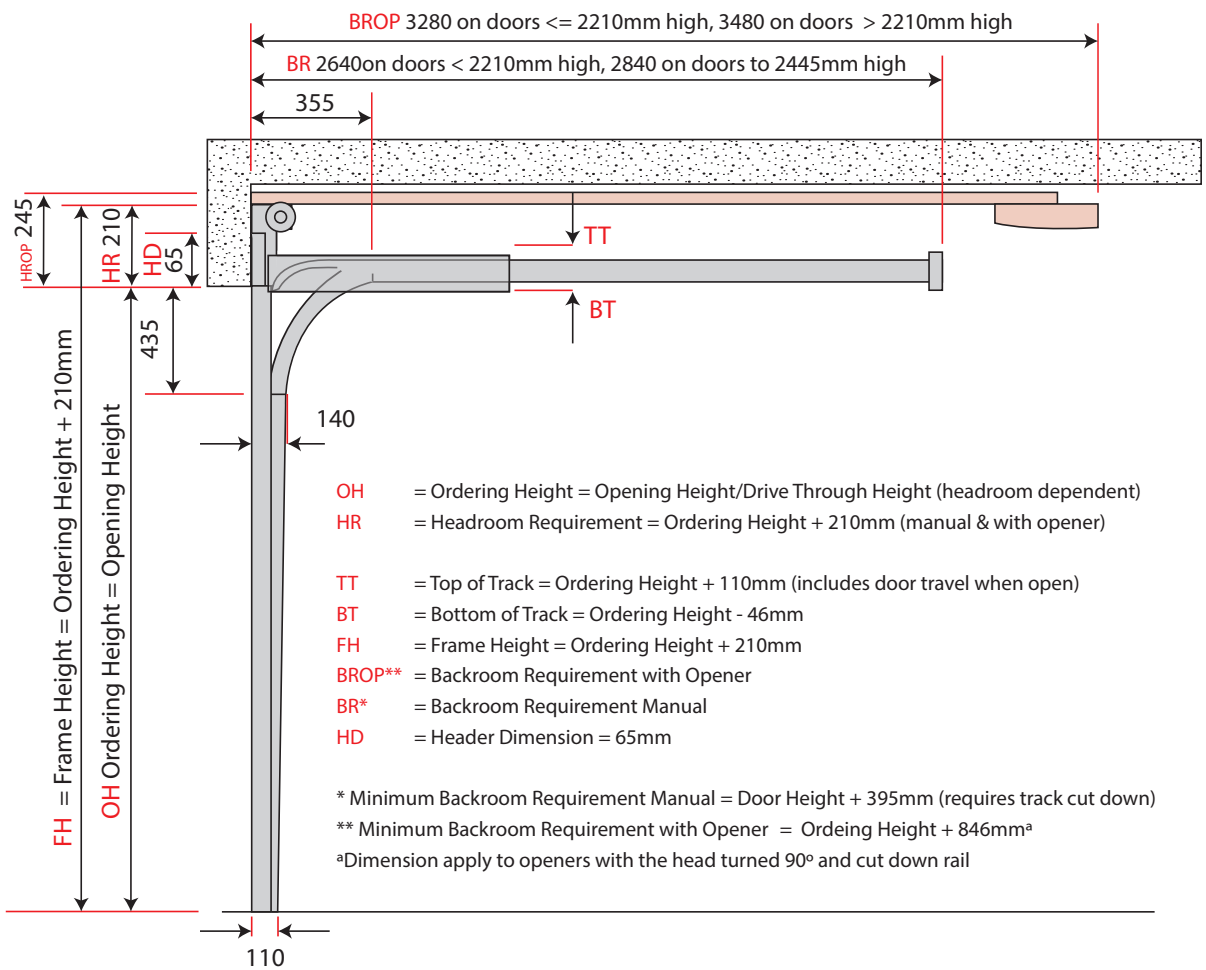

### Behind Reveal Fix

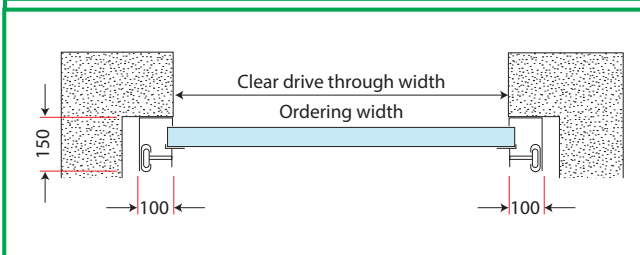

### Part Within Reveal Fix

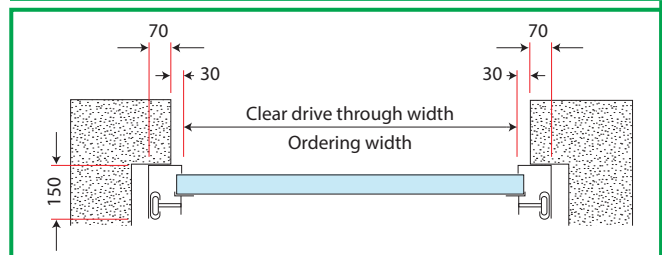

### Floor rebate

To help assist water draining away effectively from the door and prevent water ingress you must have a rebate (minimum 10mm) high behind the door threshold or where your door seal meets a level floor. If your floor is not rebated and not sloping away from the door you will be susceptible to water ingress as water will not be able to drain away effectively.

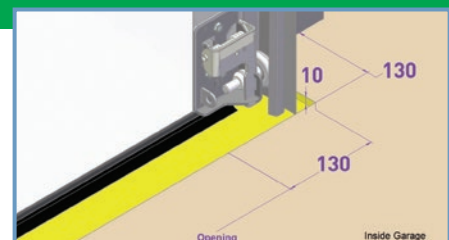

# The best performance for your door



Sectional door provides the most effective sealing of any garage door design, however this is dependent on the installation environment:

## Floor Level

Should the leading edge of your garage door or side door not meet an even level surface you will experience gaps at points across the span of your garage opening when the door is closed. The image above shows gaps resulting from an uneven threshold.

To help assist water draining away effectively from the face of your door and prevent water ingress you must have a rebate (minimum 10mm) high behind the door threshold or where your door seal meets a level floor. If your floor is not rebated and not sloping away from the face of your door you will be susceptible to water ingress as water will not be able to drain away effectively.

Your Garage Door Systems professional installer will provide you with solutions to best overcome this.

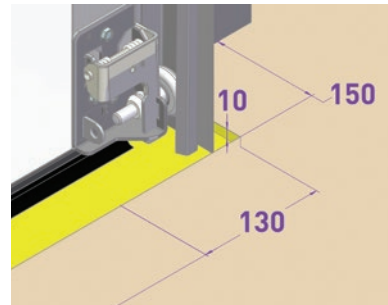

Allow for a floor rebate behind a level floor opening for improved weather protection

## How to clean and care for your door and its finish

Keeping your door looking its best doesn't require a great deal of time and requires no special skills! The most important thing is keeping your door clean.

**Cleaning:** Your door should be washed with a quality car shampoo every two months to prevent the build up of dirt, salt, grit and other corrosive substances to help maintain the aesthetic appearance of your door.

All other components must be brushed down every six months to prevent the build up of dirt, salt, grit and dust.

If your door is installed in an area prone to coastal corrosion from airborne salts, your door should be cleaned monthly. Every month you need to open the door (to expose the panel joints) and clean in between each one - particles of salt can become trapped between, creating a corrosion risk.

Clean thoroughly after bird droppings or any substance such as salt, dirt, airborne particles other than rain have found their way onto the surface of the door. This is especially important if you power wash your driveway and splash dirt/grit onto the door - dirt/grit will become trapped between the joints of the door when operating that will lead to surface marking/scuffs.

Make sure you regularly check your door and observe the directed cleaning intervals. By removing dirt, salt and grit you reduce the possibility of staining and scratching of the door surface and parts that can lead to corrosion.

Never use a powerhose/jetwash to clean your garage door.

## Service & Maintenance

Trend garage doors are durable and very robust however regular servicing is required to ensure the safe and reliable operation of your garage door...often the largest moving object in the home. It is also a requirement of the doors warranty terms. Full detail of the warranty can be found at [www.garagedoorsystems.co.uk](http://www.garagedoorsystems.co.uk).

If in doubt about service and maintenance, always consult with your Garage Door Systems Installer who will be able to offer you a regular maintenance service for your garage door.



# COMFORT, SECURITY SAFETY & STYLE

The ALUTECH Group of Companies is one of the leaders in the production of roller shutter systems and sectional doors systems in Western and Eastern Europe, and a leading manufacturer of aluminum profile systems in the CIS countries. The group has 5 manufacturing sites, in Germany and Belarus, with sales companies covering many parts of the world.

All sites are equipped with the most up to date, high tech equipment, that include automated painting lines, high quality slitting plants for aluminium and steel coil, modern efficient line for manufacturing sandwich panels for sectional doors, roll forming lines for insulated roller door lath, lines for extruded aluminium profiles, automated complex for die casting aluminium components and modern lines for powder coating, one of the biggest lines for anodizing in CIS countries.

High-tech equipment and our own manufacturing plants allows the specialists in Alutech to control the quality of production in every stage of the manufacturing process : from procurement of raw materials to manufacturing the finished product and its packaging. The quality management system in all group companies meets the requirements of ISO 9001 International standard in TUV CERT system, which is confirmed by the corresponding certificates.

Alutech Group of Companies are actively expanding, in both its markets and products. Alutech Sectional doors are manufactured both in Germany and Belarus, with capacity of over 250,000 sectional doors each year, our main markets are Germany, UK, France, Austria, Holland and most other Eastern and Western European countries.

Trend sectional garage doors perfectly combine comfort, security and safety to provide quality and style to compliment your home.

Alutech Doors Systems



Alutech Incorporated



AluminTechno



# Great to come home to!

[www.garagedoorsystems.co.uk](http://www.garagedoorsystems.co.uk)



Garage Door Systems Limited,  
Wakehurst Ind. Est., Ballymena, BT42 3AZ

NI: Tel: 028 2565 5555 Fax: 028 2564 4030

RoI Tel: 1850 510 510 Fax: 028 2564 4030

UK Tel: 0870 242 3 242 Fax: 0800 085 2741

Email: [info@garagedoorsystems.co.uk](mailto:info@garagedoorsystems.co.uk)

Web: [www.garagedoorsystems.co.uk](http://www.garagedoorsystems.co.uk)

Authorised Specialist